

Block of the Month
Compliments of Virginia H.

School Girl's Puzzle

12 1/2" unfinished (12" finished)

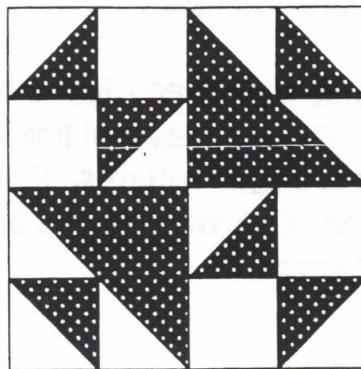

Fabric Amounts:

Light Fabric 8 1/2" x 24"

Dark Fabric 8 1/2" x 16"

Cut (See fabric layout to the right):

Fabric is folded in 1/2:
(Except when cutting only one)

Light Fabric

From the 8 1/2" strip cut

- 3 - 3 7/8" squares
- 2 - 3 1/2" x 4 1/2" rectangles
- 4 - 3 1/2" squares

Dark Fabric

From the 8 1/2" strip cut

- 1 - 6 1/2" x 7 1/2" rectangle
- 3 - 3 7/8" squares

LIGHT

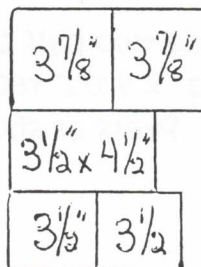

DARK

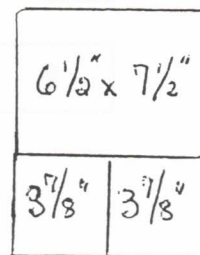

TIP: Organize your cutting. Take a few minutes to write all the cut sizes on sticky notes. Then, cut the largest pieces first, working in descending order, through each fabric.

Half Square Triangles

Using the three Light $3\frac{7}{8}$ " squares and the three Dark $3\frac{7}{8}$ " squares. Draw a diagonal line from corner to corner, on the back side of the three light squares. Sew a $\frac{1}{4}$ " away from both sides of the drawn line. Cut the squares apart on the drawn diagonal line. Trim off the "dog ears".

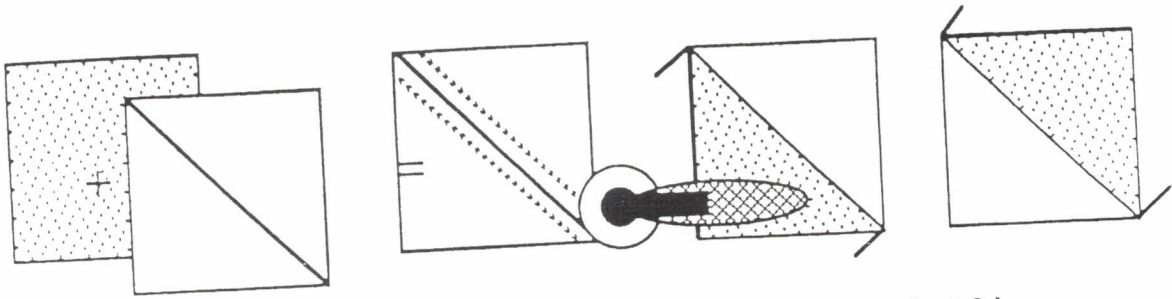

Make six (6).

Shaded Four Patch Unit

Using two half square triangles from the above step and the two Light $3\frac{1}{2}$ " x $4\frac{1}{2}$ " rectangles, follow the diagrams to construct the A/B unit. Press as shown.

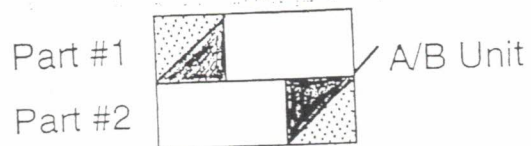
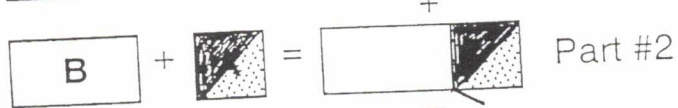
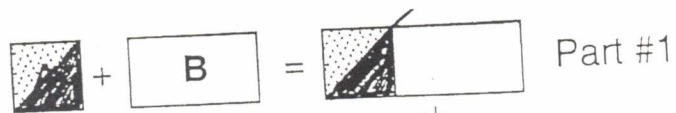

On the wrong side of C (which is your dark $6\frac{1}{2}'' \times 7\frac{1}{2}''$ rectangle), draw a diagonal line from top right corner, at a 45 degree from the $6\frac{1}{2}''$ side of the rectangle. Draw another line parallel to the first line from the opposite corner, also at a 45 degree angle.

Place C on top of the A/B unit and stitch on the lines you have drawn. Cut $\frac{1}{4}''$ from stitching as shown in diagram below.

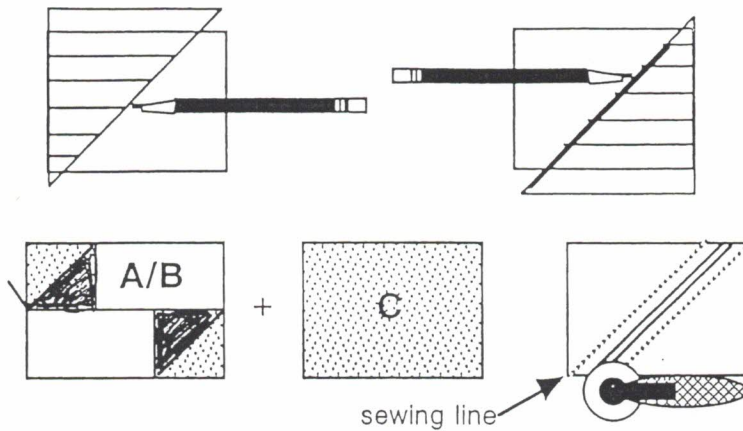

This process makes the two Shaded Four Patch Units. That's all that are needed for this block.

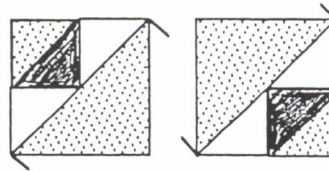

Lay out your units as shown below and stitch the units together.

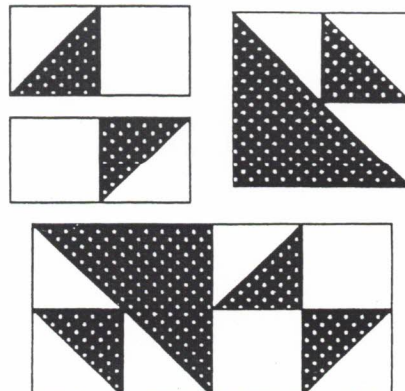

Congratulations!
You have finished
Your
Block.